

# Data Sheet



Article number: 20254018

Description: E+G Clamping pad  
GN 709.2-18-R

## Measures

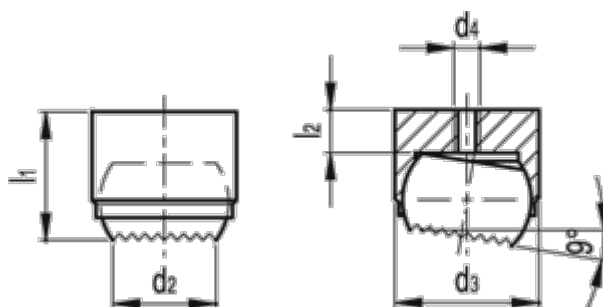

d1 m6 = 18

d2 = 10.5

d3 = 16

d4 = M4

d5 = 18

h min = 8

l1 +/-0.1 = 17.0

l2 = 4.0

Max static load (KN) = 25

Weight (g) = 30